

# LINDNER Agrarservice

Wieselrieth Nr.3 D-92705 Leuchtenberg  
Tel. 09659/93210-0  
Fax. 09659/9321013 D-Vorwahl 0049/9659/  
www.lindner-agrar.de  
Ust.-IdNr.: DE 813 2762 86

Ausgabe 01 September 2006

## Messer für Futtermischwagen (FMW)

aus deutscher Herstellung mit TÜV-Cert garantiert in Erstausrüsterqualität für folgende Fabrikate:

### Drei Beispiele aus der Liste

AGM	OMAS
AVM	Omix
Bagliari	Peecon
Cormal	RMH
Faresin	Seko
Frasto	Sgariboldi
Himel	Storti
Intendo	Strautmann
Kuhn	Supertino
Van Langerich	Unifast
Logifeed	Unifeed
Luclar	Unimix
Marmix	Walker
Mayer	

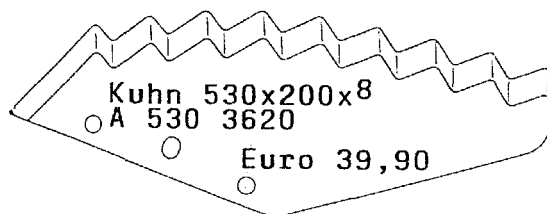
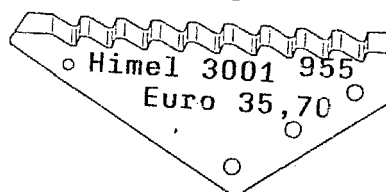
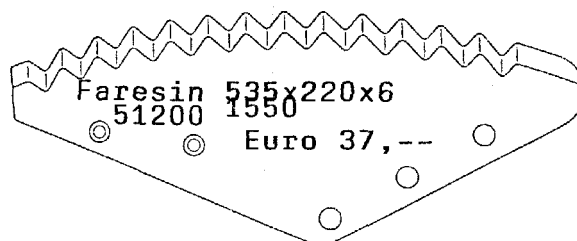

Preise:zzgl. MWSt z.Zt. 16% ab 1.1.07 19% **Lieferung:frachtfrei** in D ca. 10 Tage

**Zahlung:** Erstlieferung gegen Vorkasse oder Nachnahme

10 Tage nach Lieferung **ohne Abzug.**

**Mit 3 % Skonto** nach 10 Tagen mit Lastschriftinzug, vorausgesetzt uns liegt mit der schriftlichen Bestellung die Abbuchungsvollmacht mit Kto-Nr. und BLZ vor.

Änderungen vorbehalten – Erstbestellungen ohne Kunden Nr. bitte schriftlich per Fax 09659/9321013 e-mail [info@lindner-agrar.de](mailto:info@lindner-agrar.de)

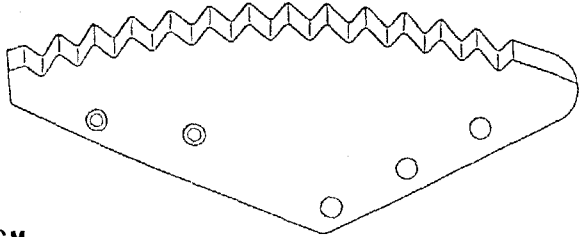
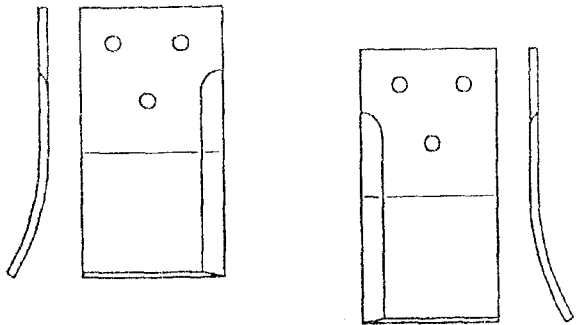
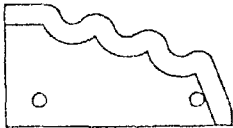
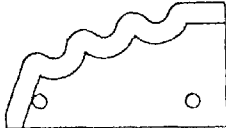
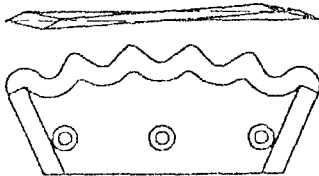
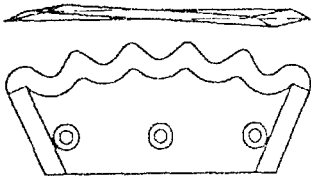
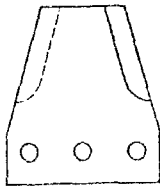
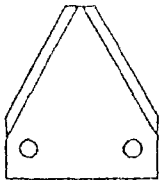
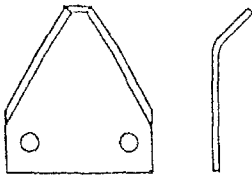

Besuchen Sie uns im Internet unter  
[www.lindner-agrar.de](http://www.lindner-agrar.de)

Geschäftszeiten: Montag – Freitag 8 bis 12 Uhr und 13 bis 17 Uhr

Messer für Futtermischwagen <b>frachtfrei</b>		plus MWSt Stck/Euro
Form	passend zu Original-Nr.	Bestell-Nr.
 <p><b>AGM</b></p> 	<p>Messer für FMW 535 x 220 x 6 AGM 01030174</p> <p>Messer für FMW 160 x 80 x 5 AGM C 08005, links AGM C 08004, rechts</p>	<p><b>Euro 37,20</b></p> <p>30-0530-64-01-0 (Ersatz für 30-0530-63-01-0)</p> <p><b>Euro 5,67</b></p> <p>30-0160-31-01-0 30-0160-32-01-0</p>
 <p><b>AVM</b></p> 	<p>Messer für FMW 143 x 80 x 5 AVM Italmix, links AVM Italmix, rechts</p>	<p><b>Euro 18,--</b></p> <p>30-0140-63-01-0 30-0140-64-01-0</p>
 <p><b>Bagliari</b></p> 	<p>Messer für FMW 260 x 110 x 7,5 hartstoffbeschichtet Bagliari, links Bagliari, rechts</p>	<p><b>Euro 52,40</b></p> <p>30-0260-72-01-0 30-0260-71-01-0</p>
<p><b>Cormal</b></p> 	<p>Fräsmesser Klinge 84 x 75 x 3, gerade Cormal</p>	<p><b>Euro 4,30</b></p> <p>50-0084-21-01-0</p>
<p><b>Faresin</b></p>  	<p>Fräsmesser Klinge, glatt 88 x 76 x 3, ø 8,6, gerade Faresin 30842 8750 30845 0150</p> <p>Fräsmesser Klinge, glatt 80 x 76 x 3, ø 8,6, abgewinkelt Faresin 30842 8650 30845 0250</p>	<p><b>Euro 2,--</b></p> <p>50-0088-11-01-0</p> <p><b>Euro 1,95</b></p> <p>50-0088-21-01-0</p>

frachtfrei

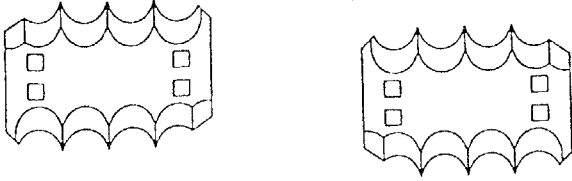
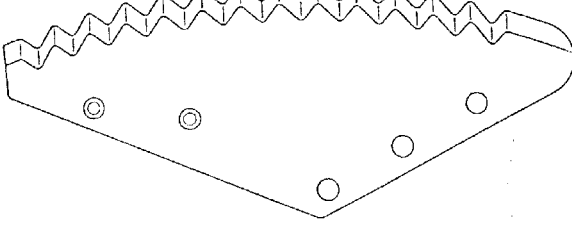
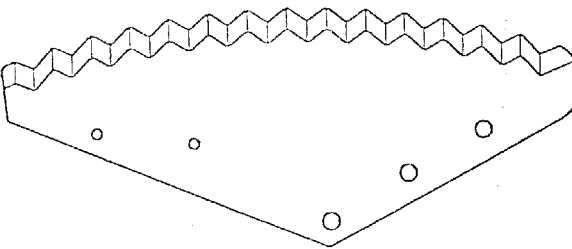
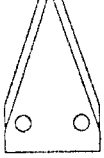
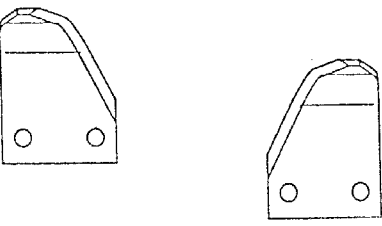
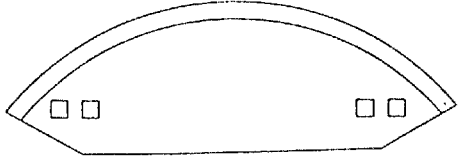
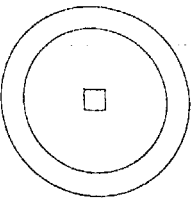
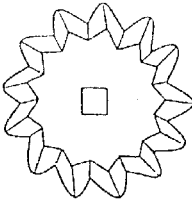
plus MWSt Stck/Euro

Form	passend zu Original-Nr.	Bestell-Nr.
	<p>Messer für FMW 140 x 102 x 6 Faresin 30845 9950, links Faresin 30845 9950, rechts</p>	<p><b>Euro 14,60</b> 30-0140-61-01-0 30-0140-62-01-0</p>
	<p>Messer für FMW 535 x 220 x 6 Faresin 51200 1550</p>	<p><b>Euro 37,--</b> 30-0530-64-01-0</p>
	<p>Messer für FMW 543 x 222 x 6 Faresin 51200 6450</p>	<p><b>Euro 36,90</b> 30-0540-70-01-0</p>
<p>Faresin</p> 	<p>Fräsmesser Klinge, glatt 80 x 50,5 x 3, ø 8,2, gerade Faresin</p>	<p><b>Euro 2,40</b> 50-0080-08-01-0</p>
	<p>Fräsmesser Klinge, glatt 100 x 55 x 3, ø 8,2 Faresin, links abgewinkelt Faresin, rechts abgewinkelt</p>	<p><b>Euro 3,95</b> 50-0100-91-01-0 50-0100-92-01-0</p>
	<p>Messer für FMW 280 x 92 x 6 Faresin</p>	<p><b>Euro 21,85</b> 30-0285-41-01-0</p>
<p>Frasto</p>   	<p>Schneidscheibe, glatt Ø 95 x 5 mit □ 10,5 Frasto 1680 0020</p> <p>Schneidscheibe, gez. Ø 94 x 5 mit □ 11 Frasto 1680 0014</p> <p>Schraube mit Sicherungsmutter M 10 x 30 Frasto</p>	<p><b>Euro 4,10</b> 30-0100-43-01-0</p> <p><b>Euro 6,20</b> 30-0100-52-01-0</p> <p><b>Euro 1,10</b> 80-4-0595</p>

frachtfrei

plus MWSt

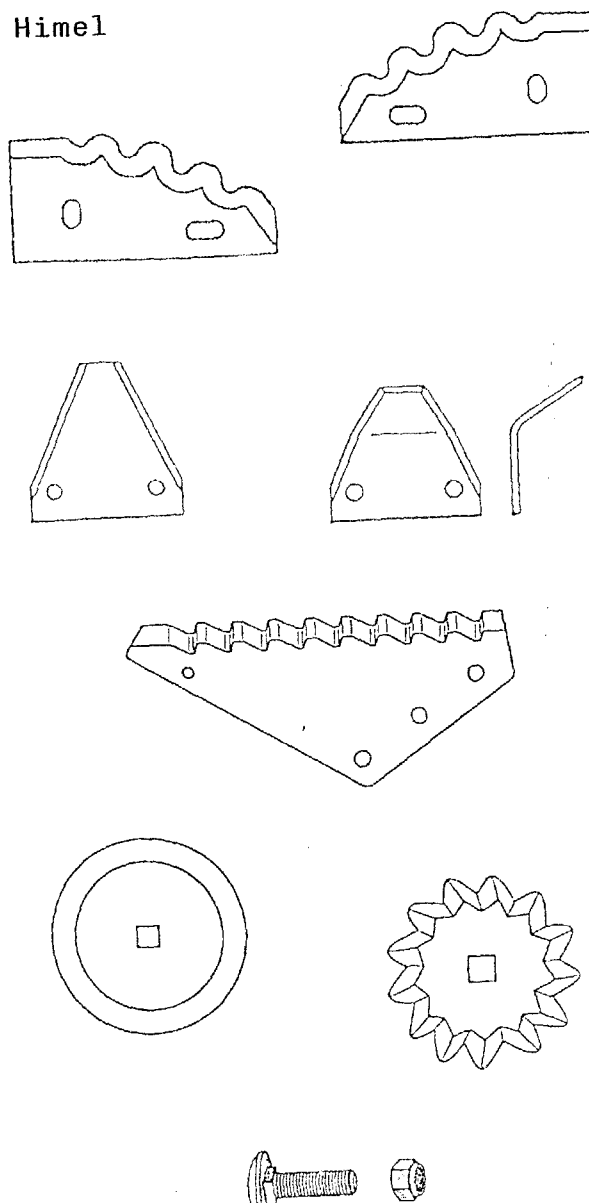
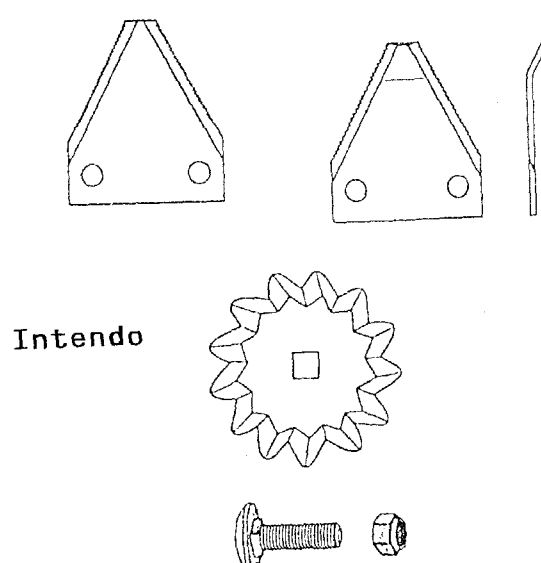

Stck/Euro

Form	passend zu Original-Nr.	Bestell-Nr.
<p><b>Himel</b></p> 	<p>Messer für FMW 195 x 90 x 5 Himel 3000 581, links Himel 3000 461, rechts</p> <p>Messer für FMW 195 x 90 x 5 hartstoffbeschichtet Himel 3000 581, links Himel 3000 461, rechts</p> <p>Fräsmesser Klinge, glatt 82 x 76 x 3, <math>\varnothing</math> 8,2; gerade Himel 3000 655</p> <p>Fräsmesser Klinge, glatt 68 x 76 x 3, <math>\varnothing</math> 8,2; abgewinkelt Himel 3000 656</p> <p>Messer für FMW 434 x 190 x 6 Himel 3001 955</p> <p>Schneidscheibe, glatt <math>\varnothing</math> 95 x 5 mit <math>\square</math> 10,5 Himel</p> <p>Schneidscheibe, gez. <math>\varnothing</math> 94 x 5 mit <math>\square</math> 11 Himel</p> <p>Schraube mit Sicherungsmutter M 10 x 30 Himel</p>	<p><b>Euro 19,95</b> 30-0210-72-01-0 30-0210-71-01-0</p> <p><b>Euro 30,--</b> 30-0210-77-01-0 30-0210-78-01-0</p> <p><b>Euro 2,90</b> 50-0080-02-01-0</p> <p><b>Euro 3,--</b> 50-0080-21-01-0</p> <p><b>Euro 35,70</b> 30-0430-69-01-0</p> <p><b>Euro 4,20</b> 30-0100-43-01-0</p> <p><b>Euro 6,20</b> 30-0100-52-01-0</p> <p><b>Euro 1,10</b> 80-4-0595</p>
<p><b>Intendo</b></p> 	<p>Fräsmesser Klinge, gezahnt 88 x 76 x 3, <math>\varnothing</math> 10,5; gerade Intendo</p> <p>Fräsmesser Klinge, gezahnt 87 x 76 x 3, <math>\varnothing</math> 10,5; abgewinkelt Intendo</p> <p>Schneidscheibe, gezahnt <math>\varnothing</math> 94 x 5 mit <math>\square</math> 11 Intendo</p> <p>Schraube mit Sicherungsmutter M 10 x 30 Intendo</p>	<p><b>Euro 2,60</b> 50-0088-55-01-0</p> <p><b>Euro 3,90</b> 50-0088-54-01-0</p> <p><b>Euro 6,20</b> 30-0100-52-01-0</p> <p><b>Euro 1,10</b> 80-4-0595</p>

frachtfrei

plus MWSt

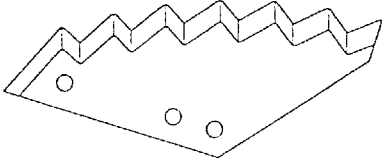
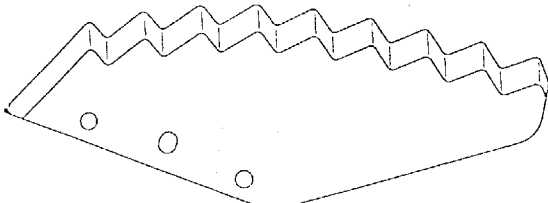
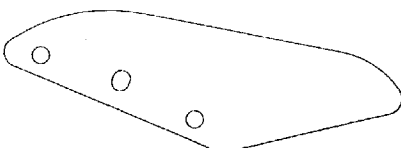
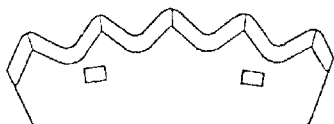

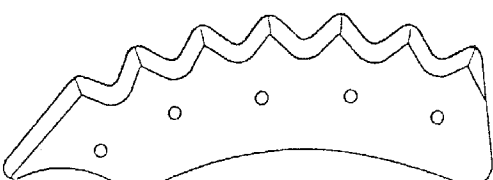
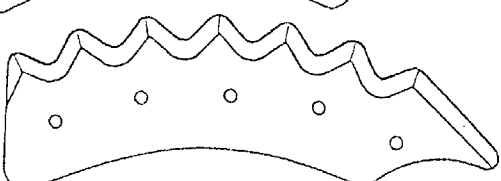
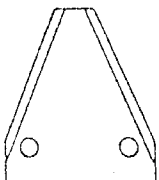
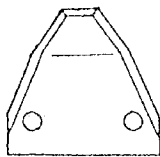
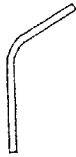
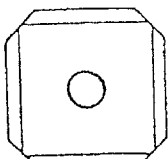
Stck/Euro

Form	passend zu Original-Nr.	Bestell-Nr.
 <p><b>Kuhn</b></p>	Messer für FMW 385 x 160 x 8 Kuhn A 530.2190	<b>Euro 32,80</b> 30-0380-66-01-0
	Messer für FMW 520 x 200 x 8 Kuhn A 530.3620	<b>Euro 39,90</b> 30-0520-62-01-0
	Messerhalterung 380 x 116 x 10,5 Kuhn A 530.3770	<b>Euro 16,40</b> 70-0380-01-01-0
	Messer für FMW 286 x 107 x 6 Kuhn A 531.0401	<b>Euro 30,30</b> 30-0290-63-01-0
	Messer für FMW 241 x 75 x 6 Kuhn A 531.0402	<b>Euro 29,30</b> 30-0240-61-01-0
	Messer für FMW 450 x 120 x 8 Kuhn A 533.0433, links Kuhn A 533.0291, rechts	<b>Euro 62,--</b> 30-0450-64-01-0 30-0450-65-01-0
		
  	Fräsmesser Klinge, glatt 85 x 76 x 3, ø 6,5, gerade Kuhn A 715.3002 Fräsmesser Klinge, glatt 72 x 76 x 3, ø 6,5, abgewinkelt Kuhn A 715.3001	<b>Euro 2,80</b> 50-0085-11-01-0 <b>Euro 3,--</b> 50-0085-21-01-0
	Schneidscheibe, glatt 85 x 85 x 4 mit ø 12,5 Kuhn A 715.3000	<b>Euro 5,70</b> 30-0100-51-01-0

frachtfrei

plus MWSt

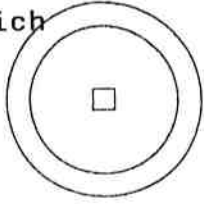
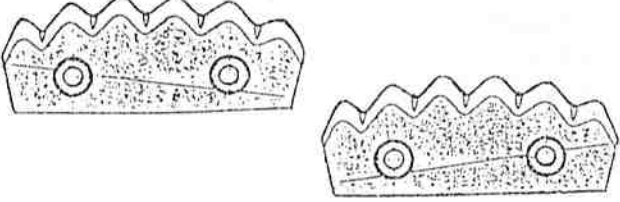
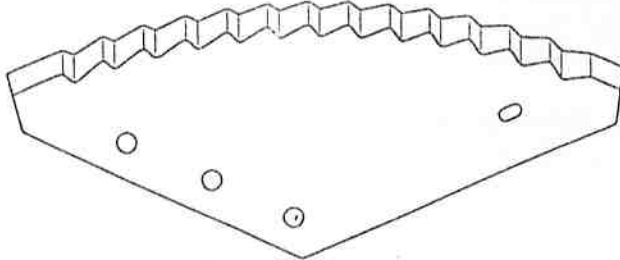
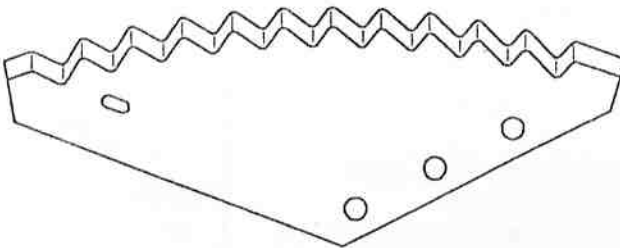
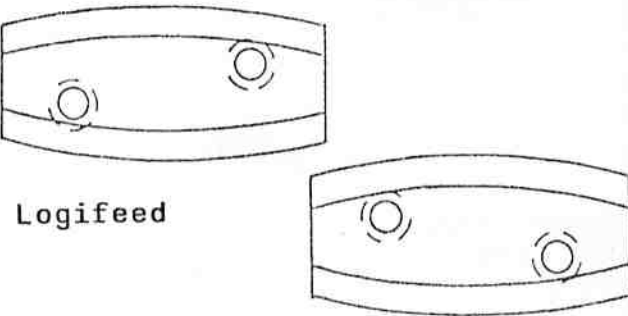
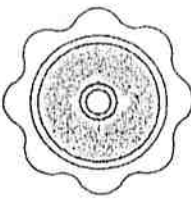

Stck/Euro

Form	passend zu Original-Nr.	Bestell-Nr.
<p>van Lengerich</p>    	<p>Schneidscheibe, glatt  <math>\varnothing</math> 95 x 5 mit <math>\square</math> 11,5  van Lengerich 65.598</p> <p>Messer für FMW  195 x 90 x 5  van Lengerich 78.364, links  van Lengerich 78.363, rechts</p> <p>Messer für FMW  547 x 220 x 6  van Lengerich 79.723</p> <p>Messer für FMW  557 x 215 x 6  van Lengerich</p>	<p><b>Euro 5,20</b>  80-4-0487</p> <p><b>Euro 19,60</b>  80-4-0673  80-4-0674</p> <p><b>Euro 47,25</b>  30-0550-63-01-0</p> <p><b>Euro 37,80</b>  30-0550-65-01-0</p>
 <p>Logifeed</p>	<p>Messer für FMW  130 x 62 x 10  Logifeed 553.421.00, links  Logifeed 553.420.00, rechts</p>	<p><b>Euro 13,10</b>  30-0120-22-01-0  30-0120-23-01-0</p>
<p>Luclar</p>  	<p>Schneidscheibe, gewellt  <math>\varnothing</math> 95 x 7 mit <math>\varnothing</math> 12  Luclar</p>	<p><b>Euro 5,20</b>  80-4-0559</p>

frachtfrei

plus MWSt

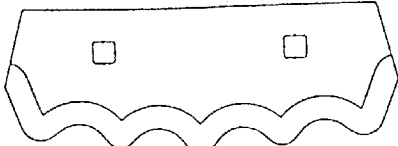
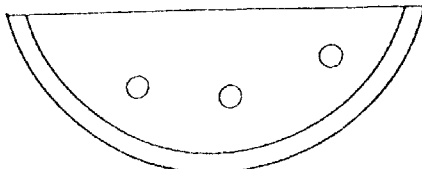
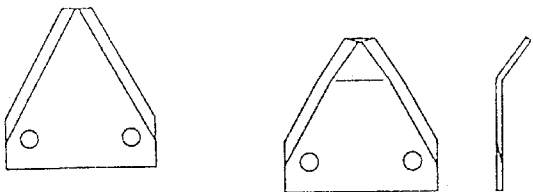
Stck/Euro

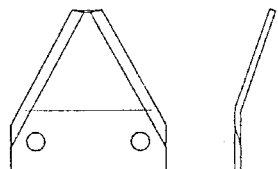
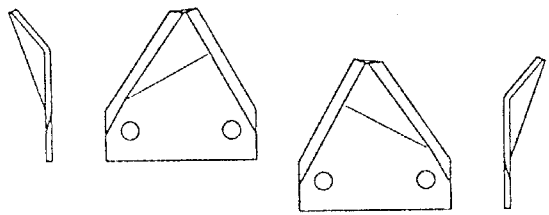
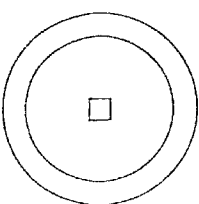
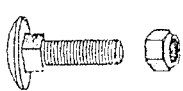
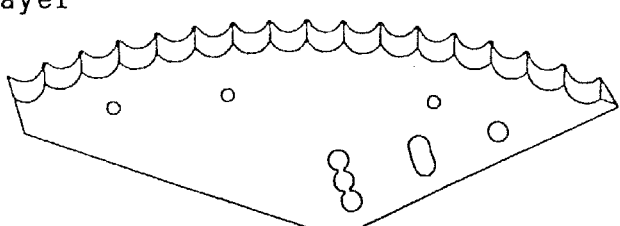
Form	passend zu Original-Nr.	Bestell-Nr.
 <p>Marmix</p>	<p>Messer für FMW 195 x 75 x 5 Marmix 128/2</p>	<p><b>Euro 24,--</b> 30-0200-61-01-0</p>
	<p>Schneidscheibe für Silofräse 350 x 137 x 7 Marmix</p>	<p><b>Euro 24,20</b> 30-0350-21-01-0</p>
	<p>Fräsmesser Klinge, glatt 80 x 76 x 3, ø 9, gerade Marmix 363</p>	<p><b>Euro 2,80</b> 50-0080-25-01-0</p>
	<p>Fräsmesser Klinge, glatt 76 x 76 x 3, ø 9, abgewinkelt Marmix 362</p>	<p><b>Euro 3,--</b> 50-0080-26-01-0</p>
	<p>Fräsmesser Klinge, glatt 78 x 76 x 3, ø 9, abgewinkelt Marmix 364</p>	<p><b>Euro 3,--</b> 50-0078-21-01-0</p>
	<p>Fräsmesser Klinge, glatt 76 x 76 x 3, ø 9 Marmix 365 SX, links abgewi. Marmix 366 DX, rechts abgewi.</p>	<p><b>Euro 2,80</b> 50-0080-27-01-0 50-0080-28-01-0</p>
  	<p>Schneidscheibe, glatt Ø 95 x 5 mit □ 10,5 Marmix</p> <p>Schraube mit Sicherungsmutter M 10 x 30 Marmix</p>	<p><b>Euro 4,10</b> 30-0100-43-01-0</p> <p><b>Euro 1,10</b> 80-4-0630</p>
<p>Mayer</p> 	<p>Messer für FMW 560 x 194 x 5 Mayer 1050030</p> <p>Messer für FMW 560 x 194 x 5 hartstoffbeschichtet Mayer 1050170</p>	<p><b>Euro 33,--</b> 30-0560-70-01-0</p> <p><b>Euro 54,--</b> 30-0560-69-01-0</p>

frachtfrei

plus MWst

Stck/Euro

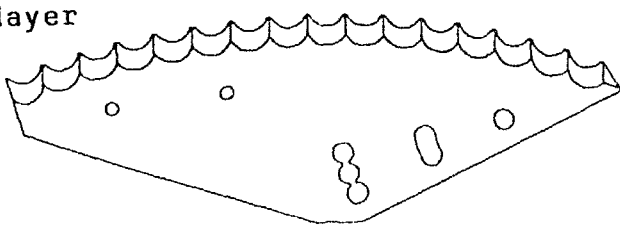
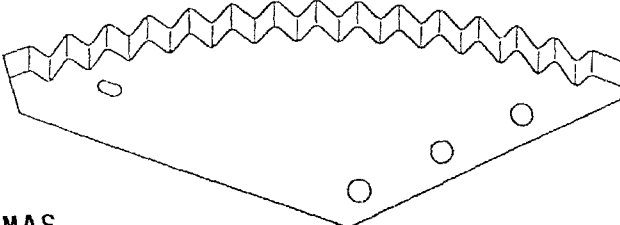
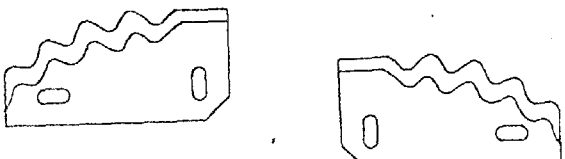
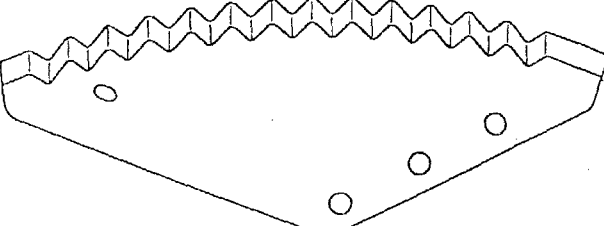
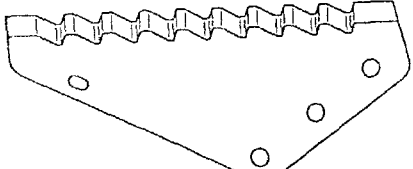
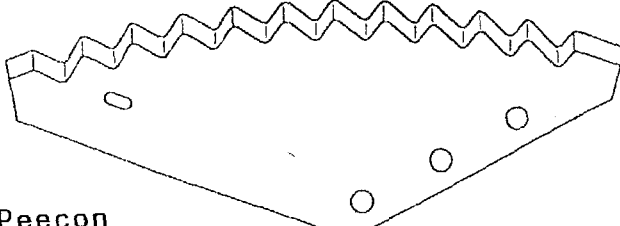
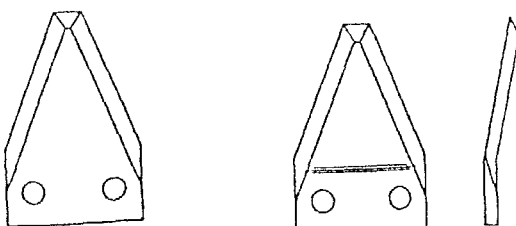
Form	passend zu Original-Nr.	Bestell-Nr.
<b>Mayer</b> 	Messer für FMW 560 x 194 x 5 Mayer 1050254  Messer für FMW 560 x 194 x 5 hartstoffbeschichtet Mayer 1050255	<b>Euro 33,--</b> 30-0560-67-01-0  <b>Euro 54,--</b> 30-0560-68-01-0
<b>OMAS</b>  	Messer für FMW 545 x 200 x 6 OMAS  Messer für FMW 545 x 200 x 6 hartstoffbeschichtet OMAS  Messer für FMW 165 x 78 x 5,5 OMAS, links OMAS, rechts	<b>Euro 39,20</b> 30-0560-66-01-0  <b>Euro 57,30</b> 30-0560-71-01-0  <b>Euro 20,30</b> 80-4-0433 80-4-0434
<b>Omix</b>  	Messer für FMW 556 x 215 x 6 Omix  Messer für FMW 428 x 193 x 6 Omix	<b>Euro 36,--</b> 30-0550-64-01-0  <b>Euro 35,50</b> 30-0430-68-01-0
<b>Peecon</b> 	Messer für FMW 557 x 215 x 6 Peecon	<b>Euro 37,80</b> 30-0550-65-01-0
<b>RMH</b> 	Fräsmesser Klinge, glatt 78 x 50,8 x 5, ø 8,5, gerade RMH  Fräsmesser Klinge, glatt 77 x 50,8 x 5, ø 8,5, abgewinkelt RMH	<b>Euro 7,60</b> 50-0078-11-01-0  <b>Euro 7,90</b> 50-0078-22-01-0



frachtfrei

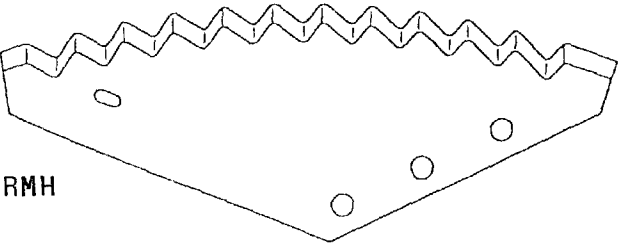
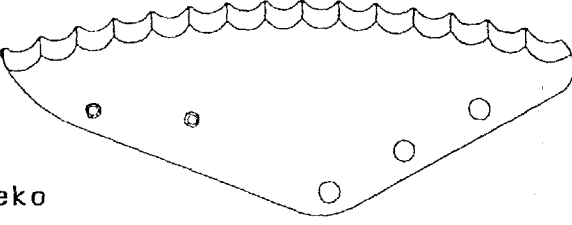
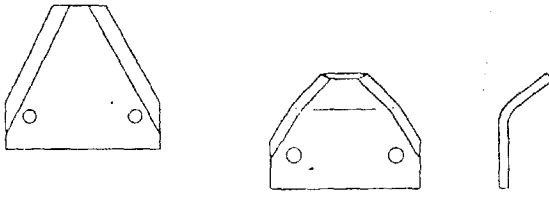
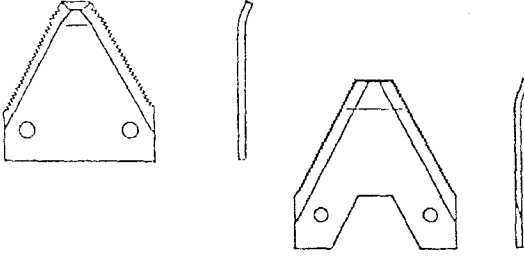
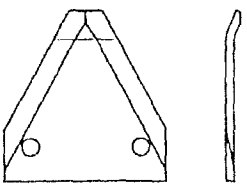
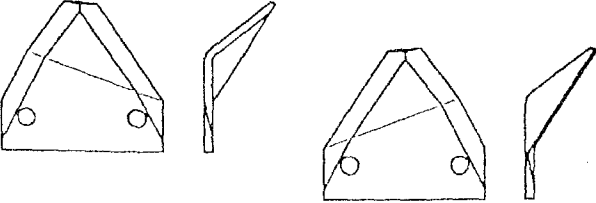
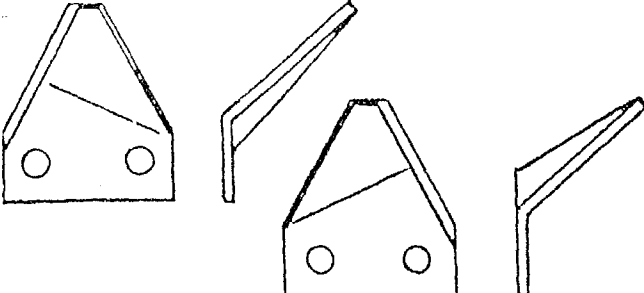

plus MWSt Stck/Euro

Form	passend zu Original-Nr.	Bestell-Nr.
 <p>RMH</p>	<p>Messer für FMW 557 x 215 x 6 RMH</p>	<p><b>Euro 37,80</b> 30-0550-65-01-0</p>
 <p>Seko</p>	<p>Messer für FMW 533 x 209 x 6 Seko 244.79060.0 desgl. hartstoffbeschichtet Seko 244.79075.0</p>	<p><b>Euro 37,80</b> 30-0530-66-01-0 <b>Euro 58,80</b> 30-0530-67-01-0</p>
	<p>Fräsmesser Klinge, glatt 70 x 76 x 4, Ø 6,5, gerade Seko 244.79009.1</p> <p>Fräsmesser Klinge, glatt 60 x 76 x 4, Ø 6,5, abgewinkelt Seko 244.79016.</p>	<p><b>Euro 2,95</b> 50-0070-13-01-0</p> <p><b>Euro 4,60</b> 50-0075-21-01-0</p>
	<p>Fräsmesser Klinge, gezahnt 80 x 76 x 3, Ø 6,5, abgewinkelt Seko 244.79043</p> <p>Fräsmesser Klinge, gezahnt 81 x 76 x 3, Ø 6,5, abgewinkelt Seko 244.79005.1</p>	<p><b>Euro 2,95</b> 50-0080-65-01-0</p> <p><b>Euro 3,--</b> 50-0080-66-01-0</p>
	<p>Fräsmesser Klinge, glatt 81 x 76 x 4, Ø 8,5, abgewinkelt Seko 244.79043.6</p>	<p><b>Euro 4,45</b> 50-0081-21-01-0</p>
	<p>Fräsmesser Klinge, glatt 81 x 76 x 4; Ø 9 links abgewinkelt Seko 244.79056.8 rechts abgewinkelt Seko 244.79055.9</p>	<p><b>Euro 4,85</b> 50-0081-22-01-0 50-0081-23-01-0</p>
	<p>Fräsmesser Klinge, glatt 70 x 76 x 3, Ø 6,5 Seko SEMG1LUA21, links abge. Seko SEMG1LUA20, rechts abge.</p>	<p><b>Euro 4,85</b> 80-4-0555 80-4-0556</p>

frachtfrei

plus MWSt

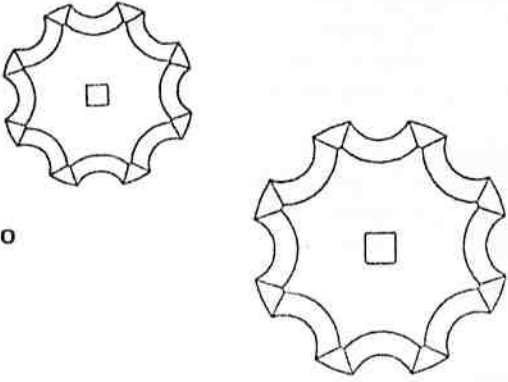
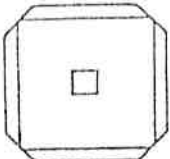
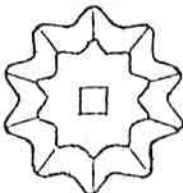
Stck/Euro

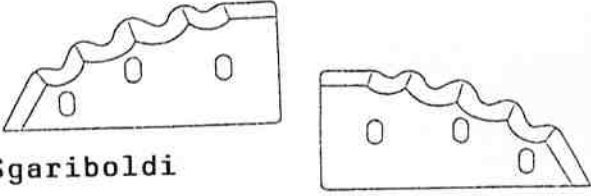
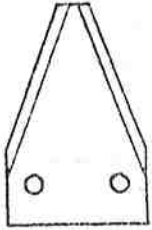
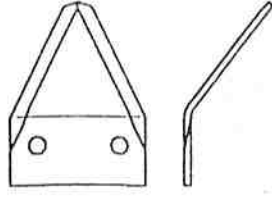
Form	passend zu Original-Nr.	Bestell-Nr.
<p data-bbox="236 443 316 477"><b>Seko</b></p>    	<p data-bbox="890 264 1193 353">Schneidscheibe, gezahnt ø 96 x 4 mit □ 10,5 Seko 244.79054.1</p> <p data-bbox="890 421 1193 510">Schneidscheibe, gezahnt ø 140 x 7 mit □ 16,5 Seko 244.79057.4</p> <p data-bbox="890 672 1161 761">Schneidscheibe, glatt 85 x 85 x 4 mit □ 10,5 Seko 244.79010.2</p> <p data-bbox="890 840 1161 929">Schneidscheibe, gez. ø 95 x 5; □ 10,5 Seko</p> <p data-bbox="890 1025 1297 1126">Schraube mit Sicherungsmutter M 10 x 30 Seko</p>	<p data-bbox="1329 275 1536 342"><b>Euro 9,10</b> 30-0100-71-01-0</p> <p data-bbox="1329 432 1536 499"><b>Euro 20,40</b> 30-0140-72-01-0</p> <p data-bbox="1329 689 1536 757"><b>Euro 4,45</b> 80-4-0621</p> <p data-bbox="1329 846 1536 913"><b>Euro 4,50</b> 80-4-0550</p> <p data-bbox="1329 1048 1536 1115"><b>Euro 1,10</b> 80-4-0595</p>
<p data-bbox="252 1373 451 1406"><b>Sgariboldi</b></p>   	<p data-bbox="906 1261 1249 1384">Messer für FMW 210 x 94 x 5 Sgariboldi CL 04.008, links Sgariboldi CL 04.014, rechts</p> <p data-bbox="906 1552 1249 1641">Fräsmesser Klinge, glatt 80 x 50,8 x 2, ø 6,5, gerade Sgariboldi</p> <p data-bbox="906 1832 1281 1933">Fräsmesser Klinge, glatt 70 x 50,5 x 2,5, ø 6,5, abgewi. Sgariboldi 07.021</p>	<p data-bbox="1345 1283 1552 1373"><b>Euro 15,10</b> 30-0215-73-01-0 30-0215-74-01-0</p> <p data-bbox="1345 1574 1552 1641"><b>Euro 2,10</b> 40-0080-14-01-0</p> <p data-bbox="1345 1854 1552 1921"><b>Euro 3,90</b> 50-0070-22-01-0</p>

frachtfrei

plus MWSt

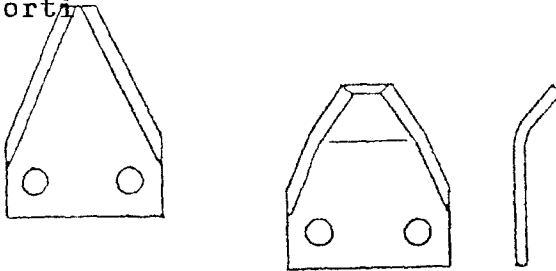
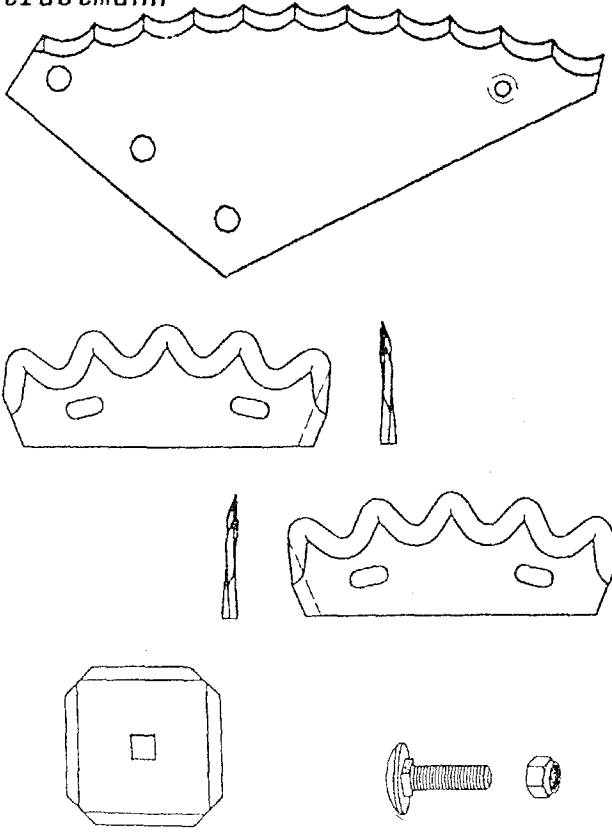
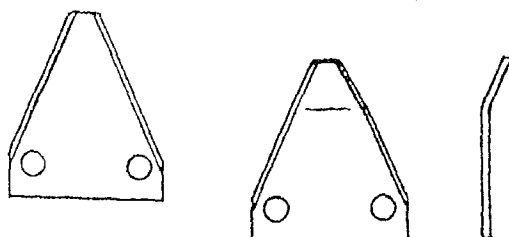

Stck/Euro

Form	passend zu Original-Nr.	Bestell-Nr.
<p><b>Sgariboldi</b> darg.: links</p> 	<p>Fräsmesser Klinge, glatt 80 x 51 x 5, <math>\varnothing</math> 7, gerade Sgariboldi, Schneide links Sgariboldi, Schneide rechts</p> <p>Fräsmesser Klinge, glatt 76 x 51 x 5, <math>\varnothing</math> 7, abgewinkelt Sgariboldi, Schneide links Sgariboldi, Schneide rechts</p>	<p><b>Euro 8,90</b> 50-0080-29-01-0 50-0080-30-01-0</p> <p>50-0080-31-01-0 50-0080-32-01-0</p>
<p><b>Storti</b></p> 	<p>Fräsmesser Klinge, glatt 88 x 76 x 3, <math>\varnothing</math> 6,5, gerade Storti</p> <p>Fräsmesser Klinge, glatt 79 x 76 x 3, <math>\varnothing</math> 6,5, abgewinkelt Storti</p>	<p><b>Euro 3,10</b> 80-4-0554</p> <p><b>Euro 3,10</b> 80-4-0553</p>
<p><b>Strautmann</b></p> 	<p>Messer für FMW 435 x 200 x 5 Strautmann 601-03.501</p> <p>Messer für FMW 215 x 80 x 5 Strautmann 605-03.502, links Strautmann 605-03.503, rechts</p> <p>Schneidscheibe, glatt 85 x 85 x 4 mit <math>\square</math> 10,5 Strautmann 218-03.501</p> <p>Schraube mit Sicherungsmutter M 10 x 30 Strautmann</p>	<p><b>Euro 30,50</b> 30-0420-67-01-0</p> <p><b>Euro 25,60</b> 30-0210-75-01-0 30-0210-76-01-0</p> <p><b>Euro 4,50</b> 80-4-0621</p> <p><b>Euro 1,10</b> 80-4-0595</p>
<p><b>Supertino</b></p> 	<p>Fräsmesser Klinge, glatt 89 x 76 x 3, <math>\varnothing</math> 10,5, gerade Supertino</p> <p>Fräsmesser Klinge, glatt 87 x 76 x 3, <math>\varnothing</math> 10,5, abgewinkelt Supertino</p>	<p><b>Euro 2,80</b> 50-0090-02-01-0</p> <p><b>Euro 3,--</b> 50-0090-53-01-0</p>

frachtfrei

plus MWSt

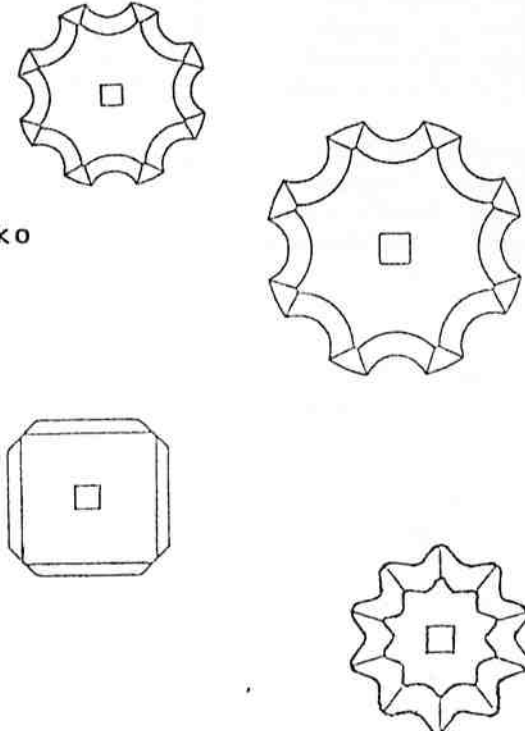
Stck/Euro

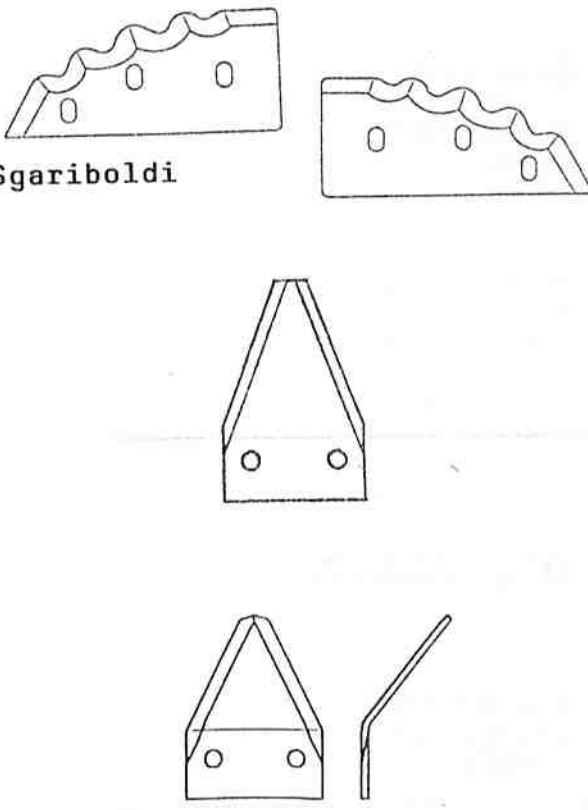
Form	passend zu Original-Nr.	Bestell-Nr.
<p data-bbox="199 443 279 474"><b>Seko</b></p>  	<p data-bbox="853 257 1157 347">Schneidscheibe, gezahnt  <math>\varnothing</math> 96 x 4 mit <math>\square</math> 10,5            Seko 244.79054.1</p> <p data-bbox="853 414 1157 504">Schneidscheibe, gezahnt  <math>\varnothing</math> 140 x 7 mit <math>\square</math> 16,5            Seko 244.79057.4</p> <p data-bbox="853 660 1157 750">Schneidscheibe, glatt            85 x 85 x 4 mit <math>\square</math> 10,5            Seko 244.79010.2</p> <p data-bbox="853 840 1157 929">Schneidscheibe, gez.  <math>\varnothing</math> 95 x 5; <math>\square</math> 10,5            Seko</p> <p data-bbox="853 1019 1157 1108">Schraube mit Sicherungsmutter            M 10 x 30            Seko</p>	<p data-bbox="1292 280 1500 347"><b>Euro 9,10</b>            30-0100-71-01-0</p> <p data-bbox="1292 436 1500 504"><b>Euro 20,40</b>            30-0140-72-01-0</p> <p data-bbox="1292 683 1500 750"><b>Euro 4,45</b>            80-4-0621</p> <p data-bbox="1292 840 1500 907"><b>Euro 4,50</b>            80-4-0550</p> <p data-bbox="1292 1041 1500 1108"><b>Euro 1,10</b>            80-4-0595</p>
<p data-bbox="215 1377 406 1411"><b>Sgariboldi</b></p> 	<p data-bbox="869 1254 1220 1377">Messer für FMW            210 x 94 x 5            Sgariboldi CL 04.008, links            Sgariboldi CL 04.014, rechts</p> <p data-bbox="869 1545 1220 1635">Fräsmesser Klinge, glatt            80 x 50,8 x 2, <math>\varnothing</math> 6,5, gerade            Sgariboldi</p> <p data-bbox="869 1825 1220 1915">Fräsmesser Klinge, glatt            70 x 50,5 x 2,5, <math>\varnothing</math> 6,5, abgewi.            Sgariboldi 07.021</p>	<p data-bbox="1308 1288 1516 1366"><b>Euro 15,10</b>            30-0215-73-01-0            30-0215-74-01-0</p> <p data-bbox="1308 1568 1516 1635"><b>Euro 2,10</b>            40-0080-14-01-0</p> <p data-bbox="1308 1848 1516 1915"><b>Euro 3,90</b>            50-0070-22-01-0</p>

frachtfrei

plus MWSt

Stck/Euro

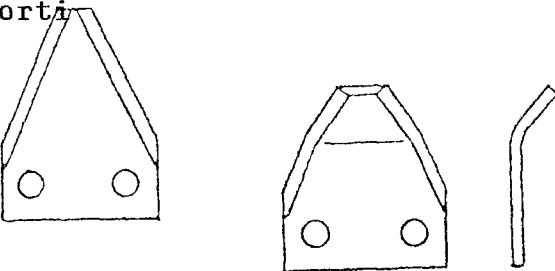
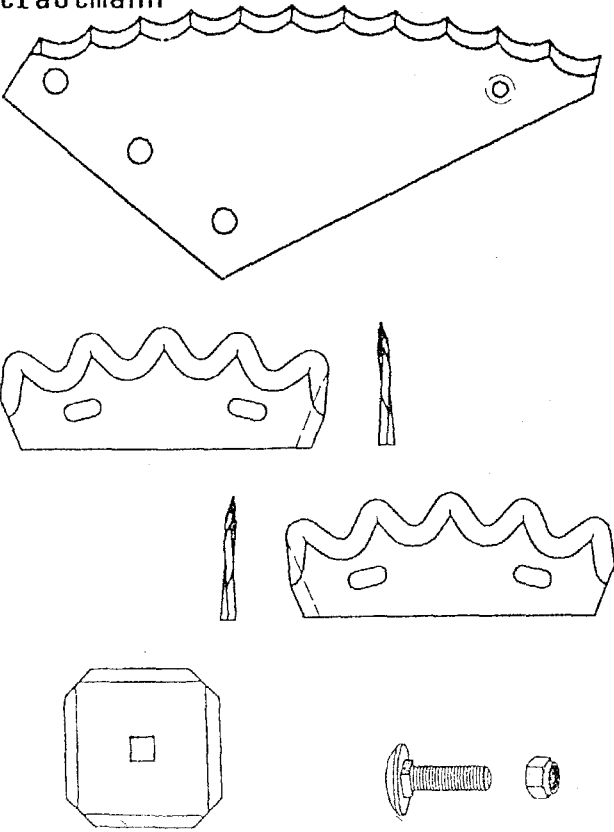
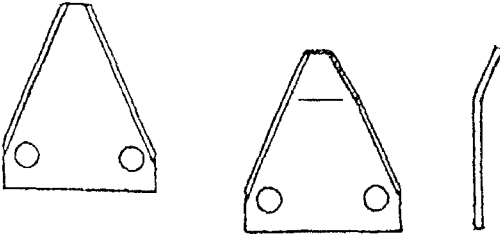

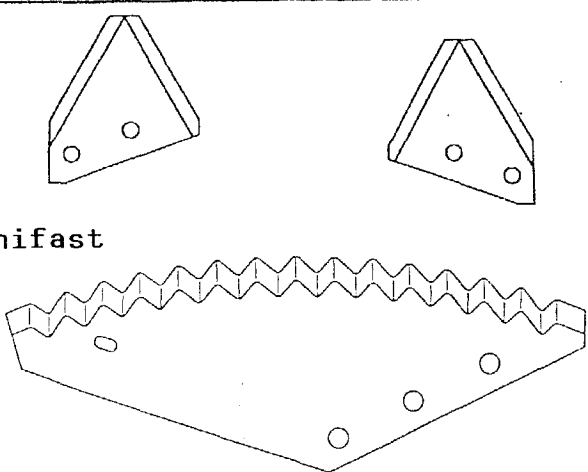
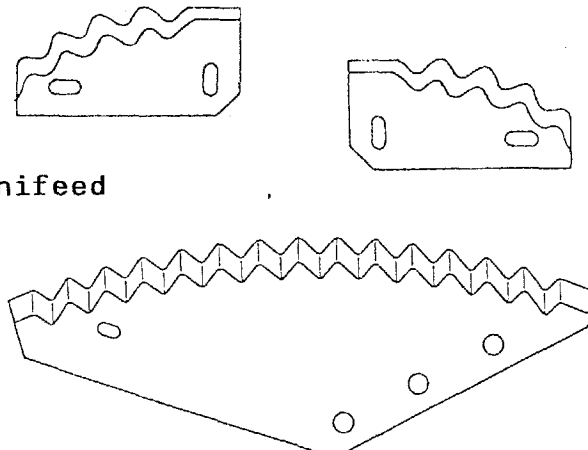
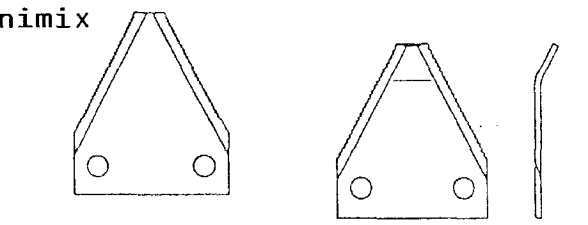
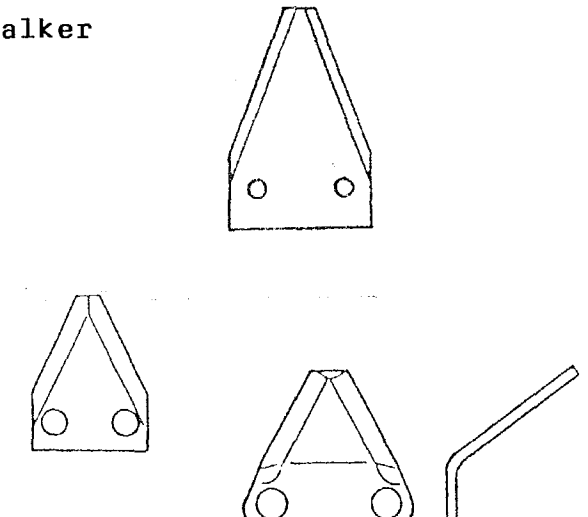
Form	passend zu Original-Nr.	Bestell-Nr.
<p><b>Sgariboldi</b> darg.: links</p> 	<p>Fräsmesser Klinge, glatt 80 x 51 x 5, <math>\varnothing</math> 7, gerade Sgariboldi, Schneide links Sgariboldi, Schneide rechts</p> <p>Fräsmesser Klinge, glatt 76 x 51 x 5, <math>\varnothing</math> 7, abgewinkelt Sgariboldi, Schneide links Sgariboldi, Schneide rechts</p>	<p><b>Euro 8,90</b> 50-0080-29-01-0 50-0080-30-01-0</p> <p>50-0080-31-01-0 50-0080-32-01-0</p>
<p><b>Storti</b></p> 	<p>Fräsmesser Klinge, glatt 88 x 76 x 3, <math>\varnothing</math> 6,5, gerade Storti</p> <p>Fräsmesser Klinge, glatt 79 x 76 x 3, <math>\varnothing</math> 6,5, abgewinkelt Storti</p>	<p><b>Euro 3,10</b> 80-4-0554</p> <p><b>Euro 3,10</b> 80-4-0553</p>
<p><b>Strautmann</b></p> 	<p>Messer für FMW 435 x 200 x 5 Strautmann 601-03.501</p> <p>Messer für FMW 215 x 80 x 5 Strautmann 605-03.502, links Strautmann 605-03.503, rechts</p> <p>Schneidscheibe, glatt 85 x 85 x 4 mit <math>\square</math> 10,5 Strautmann 218-03.501</p> <p>Schraube mit Sicherungsmutter M 10 x 30 Strautmann</p>	<p><b>Euro 30,50</b> 30-0420-67-01-0</p> <p><b>Euro 25,60</b> 30-0210-75-01-0 30-0210-76-01-0</p> <p><b>Euro 4,50</b> 80-4-0621</p> <p><b>Euro 1,10</b> 80-4-0595</p>
<p><b>Supertino</b></p> 	<p>Fräsmesser Klinge, glatt 89 x 76 x 3, <math>\varnothing</math> 10,5, gerade Supertino</p> <p>Fräsmesser Klinge, glatt 87 x 76 x 3, <math>\varnothing</math> 10,5, abgewinkelt Supertino</p>	<p><b>Euro 2,80</b> 50-0090-02-01-0</p> <p><b>Euro 3,--</b> 50-0090-53-01-0</p>

	frachtfrei	plus MWst	Stck/Euro
Form	passend zu Original-Nr.		Bestell-Nr.
<p><b>Unifast</b></p> 	<p>Fräsmesser Klinge, glatt 87 x 76 x 4, ø 8,5, gerade Unifast 16800012, links</p> <p>Unifast 16800013, rechts</p> <p>Messer für FMW 545 x 200 x 6 Unifast</p> <p>desgl. hartstoffbeschichtet Unifast</p>	<p><b>Euro 6,10</b> 30-0090-21-01-0</p> <p>30-0090-22-01-0</p> <p><b>Euro 39,20</b> 30-0560-66-01-0 (Ersatz für 30-0560-61-01-0 30-0560-62-01-0)</p> <p><b>Euro 57,--</b> 30-0560-71-01-0</p>	
<p><b>Unifeed</b></p> 	<p>Messer für FMW 165 x 78 x 5,5 Unifeed, links Unifeed, rechts</p> <p>Messer für FMW 545 x 200 x 6 Unifeed desgl. hartstoffbeschichtet Unifeed</p>	<p><b>Euro 20,30</b> 80-4-0433 80-4-0434</p> <p><b>Euro 39,20</b> 30-0560-66-01-0 <b>Euro 57,--</b> 30-0560-71-01-0</p>	
<p><b>Unimix</b></p> 	<p>Fräsmesser Klinge, gezahnt 88 x 76 x 3, ø 10,5, gerade Unimix</p> <p>Fräsmesser Klinge, gezahnt 87 x 76 x 3, ø 10,5, abgewinkelt Unimix</p>	<p><b>Euro 3,--</b> 50-0088-55-01-0</p> <p><b>Euro 4,10</b> 50-0088-54-01-0</p>	
<p><b>Walker</b></p> 	<p>Fräsmesser Klinge, glatt 80 x 50,8 x 2, ø 6,5, gerade Walker 16800008</p> <p>Fräsmesser Klinge, glatt 68 x 51 x 4, ø 8,5, gerade Walker</p> <p>Fräsmesser Klinge, glatt 62 x 90 x 4, ø 8,5, abgewinkelt Walker</p>	<p><b>Euro 2,10</b> 40-0080-14-01-0</p> <p><b>Euro 4,80</b> 50-0070-12-01-0</p> <p><b>Euro 5,20</b> 50-0070-21-01-0</p>	

frachtfrei

plus MWSt

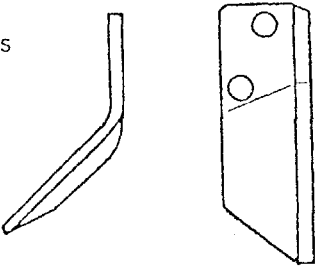
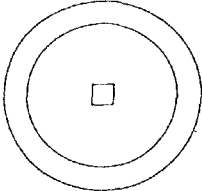
Stck7Euro

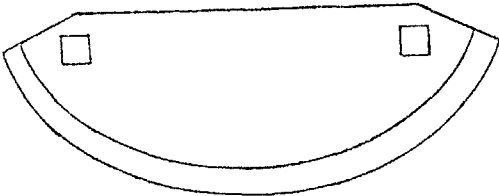
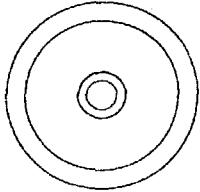
Form	passend zu Original-Nr.	Bestell-Nr.
<p><b>Walker</b> darg.: rechts</p>    	<p>Fräsmesser Klinge, glatt 90 x 40 x 4, <math>\phi</math> 6,5 Walker, links abgewinkelt Walker, rechts abgewinkelt</p> <p>Schneidscheibe, glatt <math>\phi</math> 95 x 5 mit <math>\square</math> 10,5 Walker 61000963</p> <p>Schraube mit Sicherungsmutter M 10 x 30 Walker</p> <p>Schneidscheibe für Silofräse 280 x 107 x 6 Walker</p>	<p><b>Euro 3,50</b> 80-4-0624 80-4-0623</p> <p><b>Euro 4,10</b> 30-0100-43-01-0</p> <p><b>Euro 1,10</b> 80-4-0630</p> <p><b>Euro 22,40</b> 80-4-0677</p>
	<p>Schneidscheibe, glatt <math>\phi</math> 95 x 5 mit <math>\phi</math> 11</p>	<p><b>Euro 4,10</b> 30-0100-42-01-0</p>

**Messer u. Gegenschneiden für Holzhacker u. Schredder**  
aus deutscher Herstellung mit TÜV-Cert garantiert in Erst-  
ausrüsterqualität für 33 Fabrikate

**Pflugverschleißteile garantiert in Erstausrüsterqualität**  
verarbeitet wird ausschließlich hochwertiger Spezialbohrstahl  
gehärtet, vergütet und lackiert mit einer Härte von 49-52 HRC

**Listen auf Anforderung kostenlos oder unter**  
**[www.lindner-agrar.de](http://www.lindner-agrar.de)**